

Monteringsanvisning - Assembly instruction

Piece



AB Edsbyverken, Box 300, SE-828 25 Edsbyn
Tel/Phone +46 (0)271-27500, Fax +46 (0)271-27501
www.edsbyn.com

Date:

2019-01-15

Nr:

00530214-E

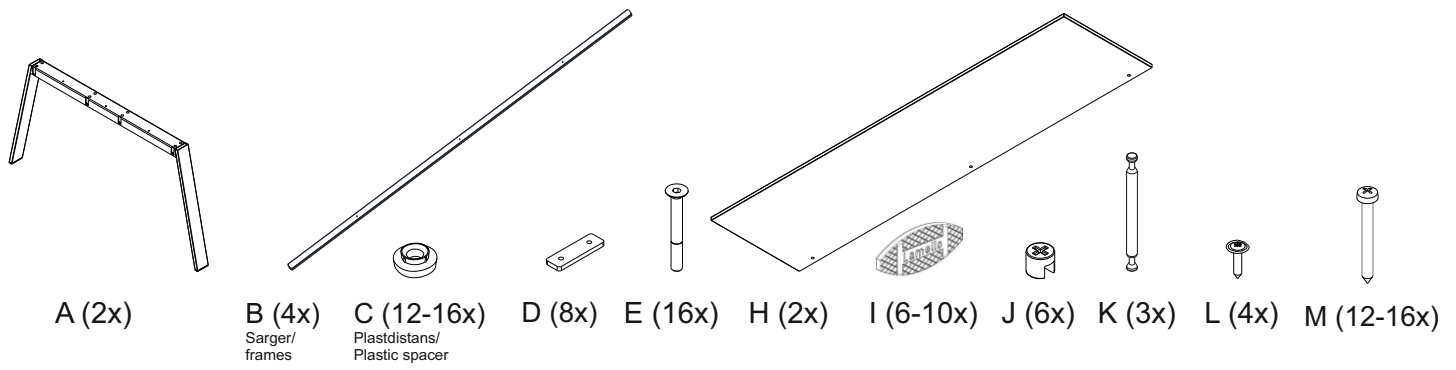

1

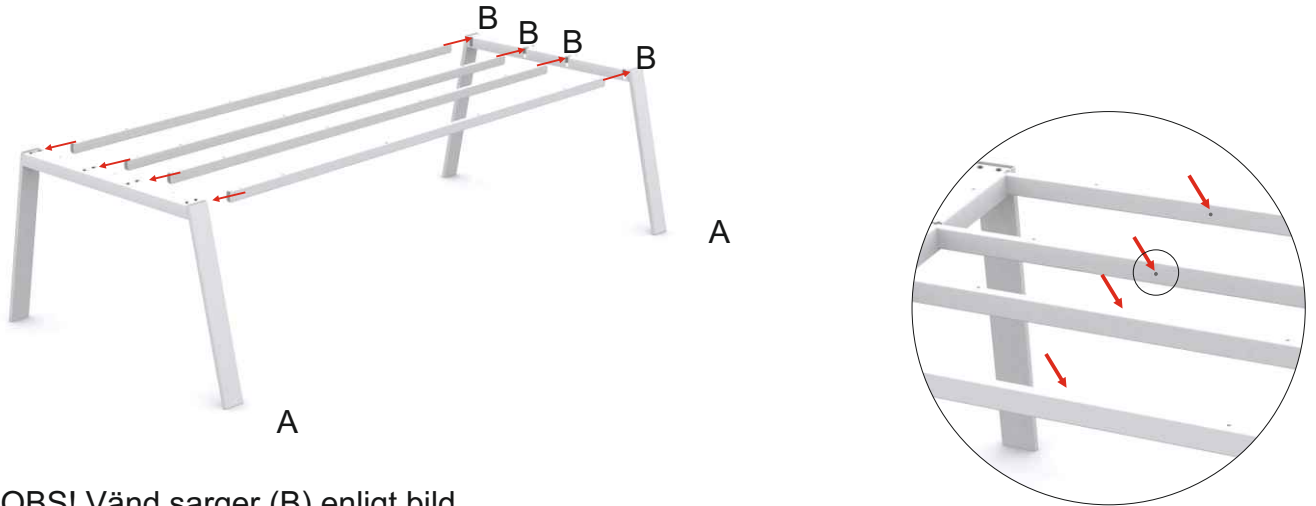

OBS! Vänd sarger (B) enligt bild.

Se till att de stora hålen hamnar uppåt mot bordsskivan, se även till att de små hålen på sidan pekar mot gavelns centrum.

NOTE! Turn the frames (B) according to picture.

Make sure that the frames is turned with the big holes up against the table top, also make sure that the small holes on the side points towards the center of the gable.

2

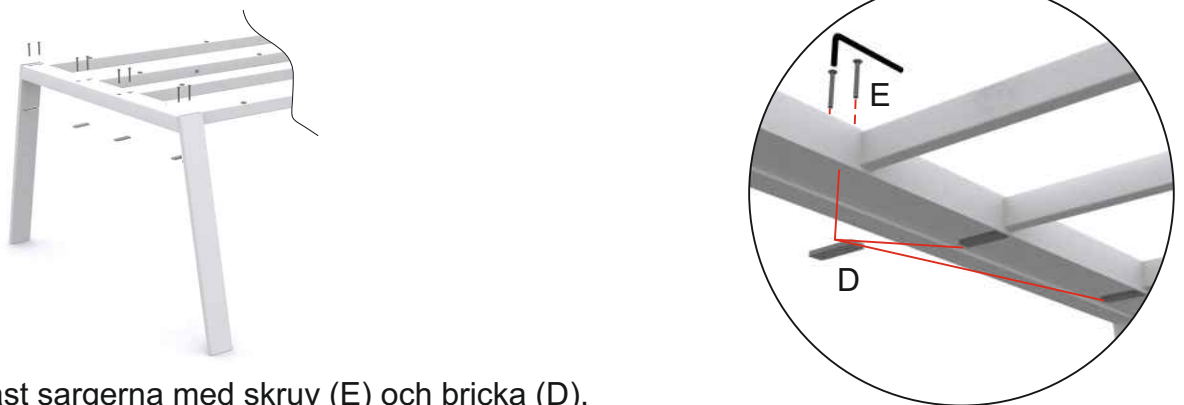

Skruva fast sargerna med skruv (E) och bricka (D).

Avsluta med att trycka fast plastdistanser (C) på ovansidan på sargerna.

Assemble the frames with screw (E) and washer (D)

Push the plastic spacer (C) on the top of the frame.

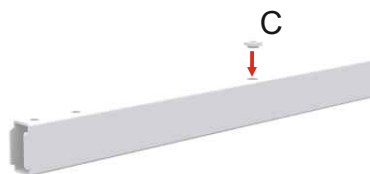

3

OBS! Bilden visar skivorna utan stativ, med baksida / undersida uppåt

NOTE! The picture shows the table tops without stand, with the back / underside up

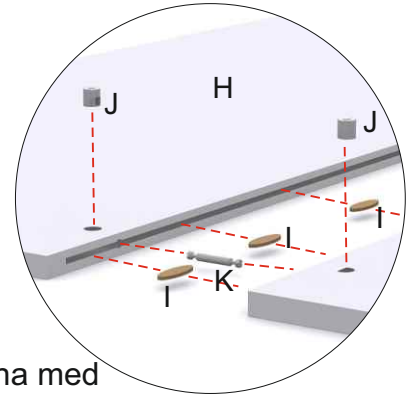
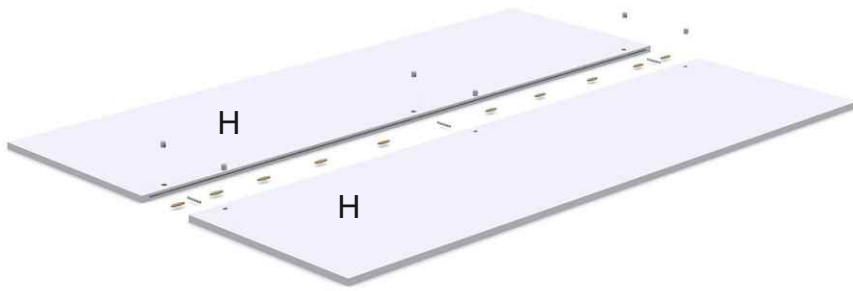

Lägg skivorna rättvänd på stativet, montera ihop de två bordsskivorna med snäcka (J) och bult (K) samt fogplatta/kex (I)

Put the table tops on the stand in the right way, assemble the two table tops with the worm (J) and the bolt (K) and the biscuits (I)

OBS! Bilden visar skivorna utan stativ, med baksida / undersida uppåt

NOTE! The picture shows the table tops without stand, with the back / underside up

4

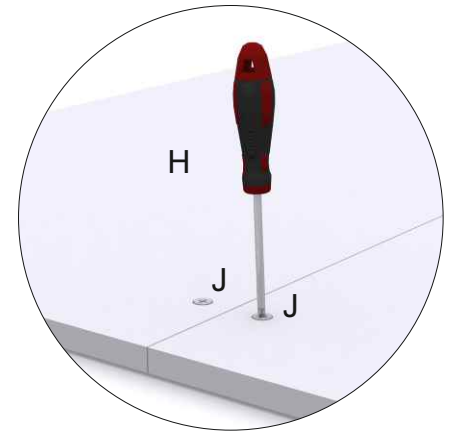
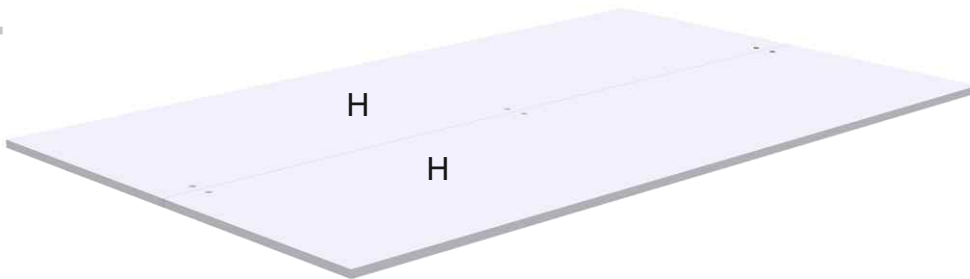

Drag åt snäckorna (J) med en skruvmejsel

Tighten the worms (J) with a screwdriver

5

Se till att skivorna ligger centrerade på stativet enligt skiss

Make sure the table tops are centered on the stand according to picture

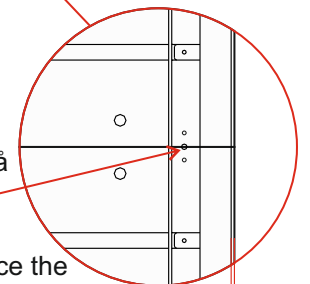
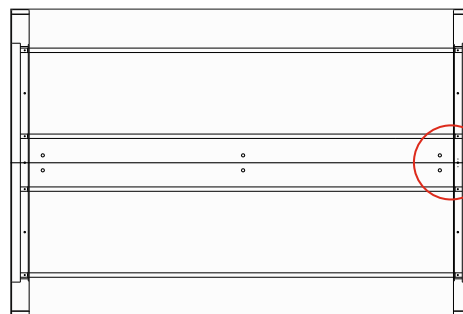

Detta hål är placerat mitt på gavel. Använd detta som riktmärke, skarv på skivorna placeras över hålet.

This hole is positioned in the center of the gable. Use this as a target, place the extension of the table tops over the hole.

Ca 4 mm från skivkant till stativ/gavel
About 4 mm from the edge to stand/gable

6

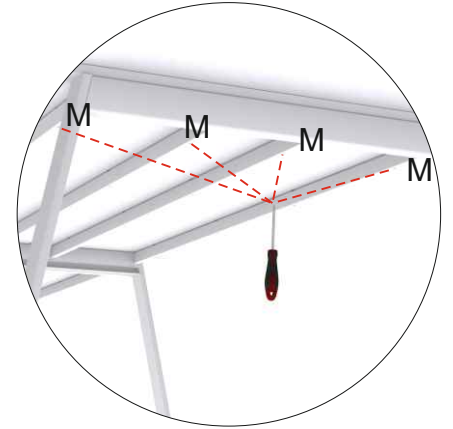
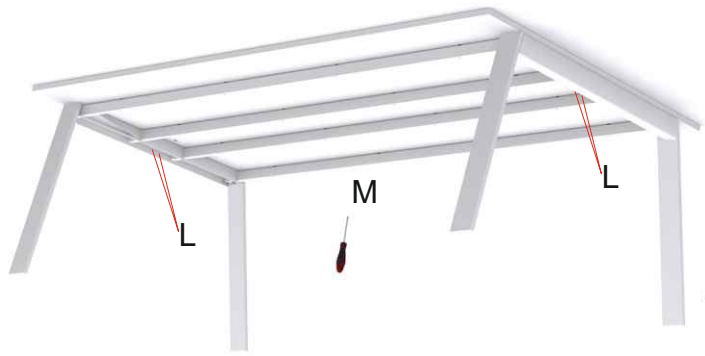

Skruva fast bordsskivan med skruv (L) och (M)
Assemble the table top with the screw (L) and (M)
