

SUPER LINE&PRO

DESIGNED BY FLOS ARCHITECTURAL

SUPER LINE
UP&DOWN
INDIRECT



LIGHT SOURCE
TOP LED
58W
4488 lm UP
2160 lm DOWN
3000K/CRI 90

4794 lm UP
2280 lm DOWN
4000K/CRI 90

SUPER LINE
UP&DOWN
DIRECT



LIGHT SOURCE
TOP LED
58W
2268 lm UP
4488 lm DOWN
3000K/CRI 90

2376 lm UP
4794 lm DOWN
4000K/CRI 90

SUPER LINE
DOWN



LIGHT SOURCE
TOP LED
38,6W
4488 lm
3000K/CRI 90
4794 lm
4000K/CRI 90

SUPER LINE PRO
UP&DOWN



LIGHT SOURCE
TOP LED
60W
UP TO 4075 lm UP
UP TO 4605 lm DOWN
3000K/CRI 90

UP TO 4337 lm UP
UP TO 4900 lm DOWN
4000K/CRI 90

SUPER LINE PRO
DOWN



LIGHT SOURCE
TOP LED
40W
UP TO 5072 lm
3000K/CRI 90
UP TO 4765 lm
4000K/CRI 90

□ 40 White
40 Blanco

■ 02 Grey
02 Gris

■ 14 Black
14 Negro

Super Line



Super Line Pro



Super Line

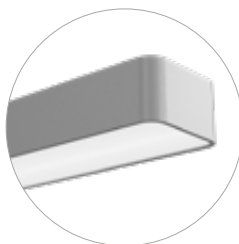

Super Line Pro



Description

Collection of suspended luminaires for general lighting with a signature minimalist shape, designed to offer high-performance lighting, light quality and visual comfort combined in a very compact size.

The Super Line Pro version was designed to meet all requirements to reduce glare and improve visual comfort in offices, complying with the most restrictive conditions. A UGR less than 14 and a maximum intensity value less than 3000 cd at an angle of 65° guarantee the best conditions for workplaces and make it perfect for many other applications. (Refer to the UGR chart in the accessories section).

The main body of the lights is made from extruded aluminium. Super Line is equipped with a multilayer diffusion filter which, thanks to its combination of elliptical and prism-shaped filters, ensures that the light is perfectly distributed and improves the overall visual effect, as well as providing comfort with its anti-glare properties.

Super Line Up&Down is available in two different versions:

- Indirect: a version which is better for emitting light indirectly upwards, with a greater intensity of indirect luminosity that homogenizes the lighting area, designed to provide UGR<19 and the perfect lighting conditions for offices.

- Direct: a version which is better for direct lighting and maximises efficiency, but at the same time prevents any "cave effect" with its indirect intensity, guaranteeing a high level of comfort.

Super Line Pro Up&Down comes in only one version that can be adjusted using the corresponding driver to offer a higher flux in the upper or lower part.

To minimise the visual impact of the collection, the suspension cables are also the wires, which eliminates the need for a power supply cable. Suspension length: 4.25 meters.

Installation Information

The Super Line is constructed combining the selected light source module with one of the three existing installation kits:

- Surface Kit: includes surface mounted box including the power supply driver.
- Integrated Kit: includes flush-recessed installation box, including power supply driver.
- Remote Power Supply Kit: includes an accessory as pass-through cable protection as well as a power supply driver for a remote accessible installation.

All installation kits are available either in DALI version or in a non dimmable version.

Super Line Pro uses the same power kits. For the Up&Down version, the power sources have two outputs to the light fitting, each with an amount of current (mA). By connecting each of these outputs to an input of the light fitting (Up or Down), a higher or lower flux can be chosen for each part.

The non dimmable versions are equipped with a multi-current driver that can be set during the installation in order to achieve the required illumination conditions. The Super Line installation kits come from factory at 100% of their nominal power.

All luminaires host a high-precision circular level, simplifying the installation of the luminaire, controlling calibration in both axes.

Additional Information

Insulation class I.
IP20 protection grade.

Standard Compliance and Quality Marks

EN60598-1 European Technical Standards and any subsequent additions.

Descripción

Colección de luminarias suspendidas para una iluminación general con una distintiva forma minimalista y diseñadas para ofrecer una iluminación de calidad y alto rendimiento, así como un confort visual, combinados en un tamaño realmente compacto.

La versión Super Line Pro ha sido diseñada para cumplir todos los requisitos contra deslumbramiento y confort visual en oficinas, que son las condiciones más restrictivas. Ofreciendo un UGR menor de 14 y un valor de intensidad máxima en un ángulo de 65° menor de 3000 cd, lo que garantiza las mejores condiciones en espacios de trabajo y la hace perfecta para muchas otras aplicaciones. (Ver tablas UGR en el apartado de Accesorios).

El cuerpo principal de las luminarias está fabricado en aluminio extruido. Super Line está equipado con un filtro difusor técnico multicapa que, gracias a su combinación de filtros prismáticos y elípticos, asegura una distribución perfecta de la luz y mejora el efecto óptico y el confort visual mediante sus propiedades antideslumbramiento.

Super Line Up&Down está disponible en dos versiones:

- Indirect: versión que privilegia la emisión indirecta hacia arriba, con una intensidad luminosa indirecta más importante que homogeneiza el entorno de iluminación, diseñada para ofrecer un UGR<19 y la condición luminosa ideal requerida en espacios de trabajo.

- Direct: versión que privilegia la iluminación directa y maximiza la eficiencia, pero al mismo tiempo previene el "efecto cueva" con su intensidad indirecta garantizando un alto nivel de confort.

Super Line Pro Up&Down solo tiene una versión que se puede ajustar mediante el driver correspondiente para ofrecer mayor cantidad de flujo en su parte superior o inferior.

Para minimizar el impacto visual de la colección los propios cables de suspensión son los conductores, por lo que se elimina la manguera de alimentación. La longitud de suspensión es de 4,25 m.

Información de Instalación

Super Line se ha creado combinando el módulo de fuente de luz seleccionado con uno de los tres kits de instalación existentes:

- Surface Kit: incluye caja para ser instalada en superficie que incluye la fuente de alimentación.
- Integrated Kit: incluye caja de instalación a ras o encastrada que incluye la fuente de alimentación.
- Remote Power Supply Kit: incluye accesorio pasamuro para proteger los cables. Incluye fuente de alimentación para una instalación accesible a distancia.

Todos los kits de instalación están disponibles en versión DALI o en versión no regulable.

Super Line PRO dispone de los mismos kits de alimentación. Para la versión Up&Down las fuentes de alimentación disponen de dos salidas hacia la luminaria, cada una con una intensidad de corriente (mA). Conectando estas salidas a cada una a las entradas (Up o Down) de la luminaria se selecciona el flujo mayoritario y minoritario en cada parte. Las versiones no regulables están equipadas con una alimentación de corriente múltiple que puede configurarse durante la instalación para conseguir las condiciones de iluminación necesarias. Los kits de instalación de Super Line vienen regulados desde nuestra fábrica con el 100% de su potencia nominal.

Todas las luminarias disponen de un nivel circular de alta precisión que simplifica la instalación de la misma y controla la calibración en ambos ejes.

Información Adicional

Clase de aislamiento I.
índice de protección IP20.

Cumplimiento de Normativa y Marcas de Calidad

Luminaria conforme con la Normativa Técnica Europea EN60598-1 y partes segundas.

FLOS
CONTROL BY CASAMBI



SUPER LINE & PRO

Super Line Up&Down Indirect

Light Source: Top LED 58W - 4488 lm UP - 2160 lm DOWN - 3000K/CRI 90 / 58W - 4794 lm UP - 2280 lm DOWN - 4000K/CRI 90

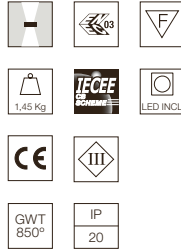
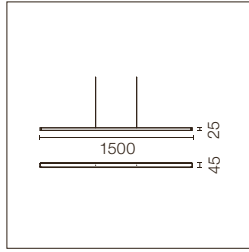

LED luminaire for direct and indirect lighting with a signature minimalist and compact design, to be installed on ceilings by means of suspension. Power source included in installation kits must be ordered separately.

Luminaria LED de iluminación general directa e indirecta con un distintivo diseño minimalista y compacto para ser instalada a techo mediante suspensión. Fuente de alimentación incluida en los distintos kits de instalación, que se han de pedir por separado.

- 3000K**
- 03.9502.40
 - 03.9502.02
 - 03.9502.14

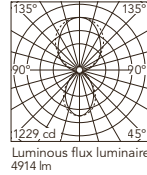

Beam Angle DIR: 101°

h(m)	E(lx)	D(m)
1	1229	2.39
2	307	4.78
3	137	7.17
4	77	9.57
5	49	11.96

- 4000K**
- 03.9503.40
 - 03.9503.02
 - 03.9503.14

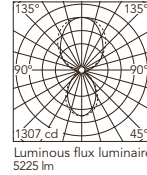

Beam Angle DIR: 101°

h(m)	E(lx)	D(m)
1	1307	2.39
2	327	4.78
3	145	7.17
4	82	9.57
5	52	11.96

Super Line Up&Down Direct

Light Source: Top LED 58W - 2268 lm UP - 4488 lm DOWN - 3000K/CRI 90 / 58W - 2376 lm UP - 4794 lm DOWN - 4000K/CRI 90

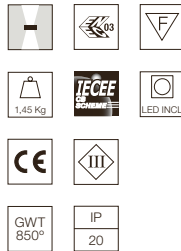
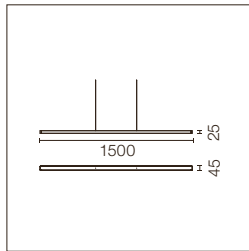

LED luminaire for direct and indirect lighting with a signature minimalist and compact design, to be installed on ceilings by means of suspension. Power source included in installation kits must be ordered separately.

Luminaria LED de iluminación general directa e indirecta con un distintivo diseño minimalista y compacto para ser instalada a techo mediante suspensión. Fuente de alimentación incluida en los distintos kits de instalación, que se han de pedir por separado.

- 3000K**
- 03.9500.40
 - 03.9500.02
 - 03.9500.14

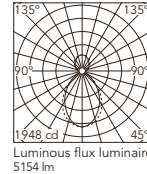

Beam Angle DIR: 82°

h(m)	E(lx)	D(m)
1	1948	1.57
2	487	3.13
3	216	4.70
4	122	6.27
5	78	7.84

- 4000K**
- 03.9501.40
 - 03.9501.02
 - 03.9501.14

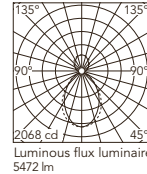

Beam Angle DIR: 82°

h(m)	E(lx)	D(m)
1	2068	1.57
2	517	3.13
3	230	4.70
4	129	6.27
5	83	7.84

Super Line Down

Light Source: Top LED 38,5W - 4488 lm - 3000K/CRI 90 / 38,5W- 4794 lm - 4000K/CRI 90

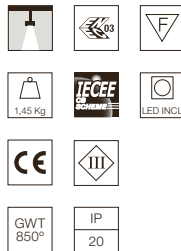
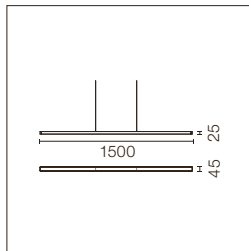

LED luminaire for general lighting with a signature minimalist and compact design, to be installed on ceilings by means of suspension. Power source included in installation kits must be ordered separately.

Luminaria LED de iluminación general con un distintivo diseño minimalista y compacto para ser instalada a techo mediante suspensión. Fuente de alimentación incluida en los distintos kits de instalación, que se han de pedir por separado.

- 3000K**
- 03.9510.40
 - 03.9510.02
 - 03.9510.14

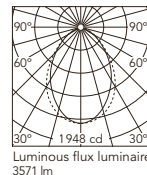

Beam Angle: 82°

h(m)	E(lx)	D(m)
1	1948	1.57
2	487	3.13
3	216	4.70
4	122	6.27
5	78	7.84

- 4000K**
- 03.9511.40
 - 03.9511.02
 - 03.9511.14

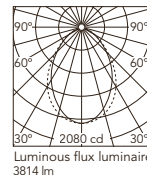

Beam Angle: 82°

h(m)	E(lx)	D(m)
1	2080	1.57
2	520	3.13
3	231	4.70
4	130	6.27
5	83	7.84

SUPER LINE & PRO

Super Line Pro Up&Down

Light Source: Majority UP - Top LED 60W - 4075 lm UP - 2500 lm DOWN - 3000K/CRI 90 / 60W - 4335 lm UP - 2660 lm DOWN - 4000K/CRI 90
 Majority DOWN - Top LED 60W - 2590 lm UP - 4605 lm DOWN - 3000K/CRI 90 / 60W - 2755 lm UP - 4900 lm DOWN - 4000K/CRI 90

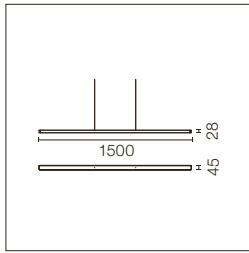

LED luminaire for direct and indirect lighting with a signature minimalist and compact design, to be installed on ceilings by means of suspension. Power source included in installation kits must be ordered separately. Greater Up or Down intensity can be selected using power kits with a device with two independent outputs.

Luminaria LED de iluminación general directa e indirecta con un distintivo diseño minimalista y compacto para ser instalada a techo mediante suspensión. Fuente de alimentación incluida en los distintos kits de instalación, que se han de pedir por separado. La selección del de mayor intensidad Up o Down, se realiza en los Kits de alimentación que disponen de un equipo con dos salidas independientes.

- 3000K**
- 03.9560.40
 - 03.9560.02
 - 03.9560.14

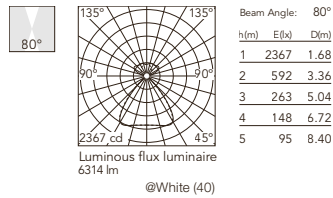
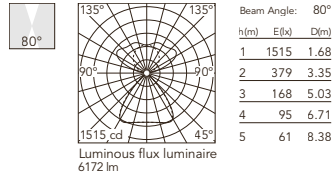

- 4000K**
- 03.9561.40
 - 03.9561.02
 - 03.9561.14

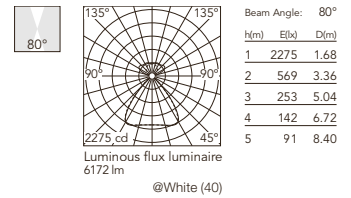
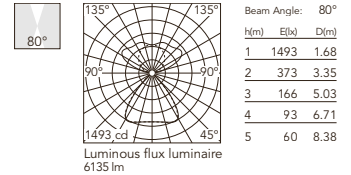

Super Line Pro Down

Light Source: Top LED 40W - 4765 lm - 3000K/CRI 90 / 40W- 5070 lm - 4000K/CRI 90

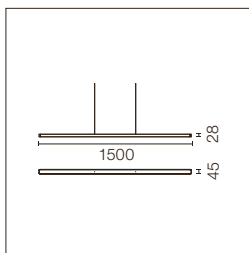

LED luminaire for general lighting with a signature minimalist and compact design, to be installed on ceilings by means of suspension. Power source included in installation kits must be ordered separately, allowing the maximum brightness to be selected.

Luminaria LED de iluminación general con un distintivo diseño minimalista y compacto para ser instalada a techo mediante suspensión. Fuente de alimentación incluida en los distintos kits de instalación, que se han de pedir por separado, pudiendo seleccionar la intensidad máxima.

- 3000K**
- 03.9570.40
 - 03.9570.02
 - 03.9570.14

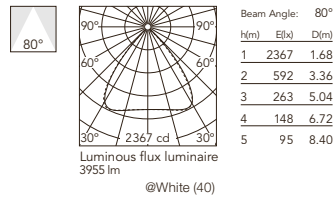

- 4000K**
- 03.9571.40
 - 03.9571.02
 - 03.9571.14

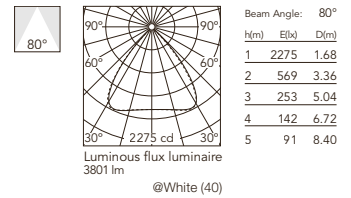

Accessories / Accesorios

The non-adjustable versions of Super Line and Super Line Pro Down are equipped with a multi-current driver, that can be set during the installation in order to achieve the required illumination conditions and comfort levels. Installation kits come from factory at 100% of their nominal power (1050 mA). At maximum power, all versions of Super Line Pro comply with the requirements UGR<19 and L 65°<3000 cd.

Las versiones no regulables de Super Line y Super Line Pro Down están equipadas con una alimentación de corriente múltiple que puede configurarse durante la instalación para conseguir las condiciones de iluminación y los niveles de confort requeridos. Los kits de instalación vienen de fábrica con el 100% de su potencia nominal (1050 mA). Super Line Pro cumple en todas sus versiones y a máxima potencia con los requisitos de UGR<19 y L 65°<3000 cd.

Super Line

Driver setting	Light emission	Indirect		Direct	
		UGR*	L 65° < 3000 cd	UGR*	L 65° < 3000 cd
1050 mA	100%	UGR < 19			
850 mA	80%	UGR < 19			
700 mA	70%	UGR < 19			
550 mA	55%	UGR < 19	√		
500 mA	50%	UGR < 19	√	UGR < 19	√
350 mA	36%	UGR < 19	√	UGR < 19	√

*X=4H, Y=8H, S=0.25H, reflections 70/50/20

Super Line Pro

Light emission	UGR*	L 65° < 3000 cd
Up & Down Majority Up	UGR < 14	√
Up & Down Majority Down	UGR < 17	√
Down	UGR < 18	√

Surface Power Supply Kit

60W – 220/240V power supply included. Kits for Super Line and Super Line Pro Down are equipped with a dip-switch driver to select the maximum intensities.

Incluye fuente de alimentación 60W - 220/240V. Los Kits para Super Line y Super Line Pro Down, disponen de driver con dip-switch para seleccionar las intensidades máximas.

80W – 220/240V power supply included. Kits for Super Line Pro Up&Down are equipped with two outputs to select which part (Up or Down) is brighter.

Incluye fuente de alimentación 80W - 220/240V. Los Kits para Super Line Pro Up&Down disponen de dos salidas para seleccionar qué parte (Up o Down) dispone de mayor intensidad.

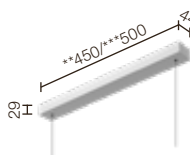

** Super Line / *** Super Line Pro

Super Line/Super Line Pro Down

Non Dimmable

08.0520.40

08.0520.02

08.0520.14

Dali Version*

08.0521.40

08.0521.02

08.0521.14

Super Line Pro Up&Down

Non Dimmable/Dali Version

08.0640.40

08.0640.02

08.0640.14

Recessed Power Supply Kit

60W – 220/240V power supply included. Kits for Super Line and Super Line Pro Down are equipped with a dip-switch driver to select the maximum intensities.

Incluye fuente de alimentación 60W - 220/240V. Los Kits para Super Line y Super Line Pro Down, disponen de driver con dip-switch para seleccionar las intensidades máximas.

80W – 220/240V power supply included. Kits for Super Line Pro Up&Down are equipped with two outputs to select which part (Up or Down) is brighter.

Incluye fuente de alimentación 80W - 220/240V. Los Kits para Super Line Pro Up&Down disponen de dos salidas para seleccionar qué parte (Up o Down) dispone de mayor intensidad.

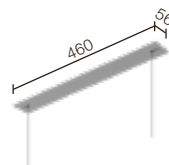

445 x 44mm



h=90 min

Super Line/Super Line Pro Down

Non Dimmable

08.0522.40

08.0522.02

08.0522.14

Dali Version*

08.0523.40

08.0523.02

08.0523.14

Super Line Pro Up&Down

Non Dimmable/Dali Version

08.0641.40

08.0641.02

08.0641.14

* For 1-10V and Push versions, please ask the Front Office/Technical Department / Para versiones 1-10V y Push consultar al Front Office/Departamento técnico.

SUPER LINE&PRO

Accessories / Accesorios

Remote Power Supply Kit

Includes two suspension kits and a 60W - 220/240V power supply. Kits for Super Line and Super Line Pro Down are equipped with a dip-switch driver to select the maximum intensities.

Incluye dos kits de suspensión y una fuente de alimentación de 60W - 220/240V. Los Kits para Super Line y Super Line Pro Down, disponen de driver con dip-switch para seleccionar las intensidades máximas.

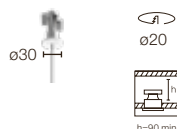

- Super Line/Super Line Pro Down
Non Dimmable
- 08.0524.40
 - 08.0524.02
 - 08.0524.14
- Dali Version*
- 08.0525.40
 - 08.0525.02
 - 08.0525.14

Includes two suspension kits and a 80W - 220/240V power supply. Kits for Super Line Pro Up&Down are equipped with two outputs to select which part (Up or Down) is brighter.

Incluye dos kits de suspensión y una fuente de alimentación de 80W - 220/240V. Los Kits para Super Line PRO Up&Down disponen de dos salidas para seleccionar qué parte (Up o Down) dispone de mayor intensidad.

- Super Line Pro Up&Down
Non Dimmable/Dali Version
- 08.0642.40
 - 08.0642.02
 - 08.0642.14

Installation Sequence

Recessed Power Supply Kit

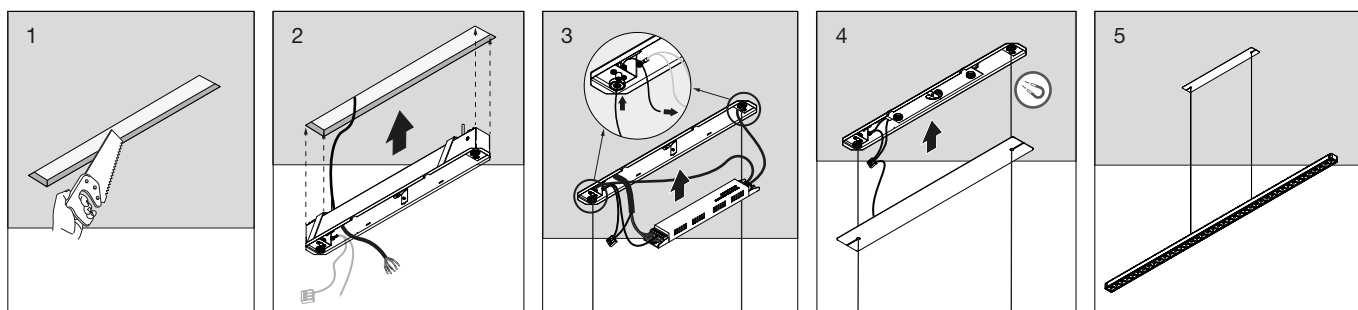

Surface Power Supply Kit

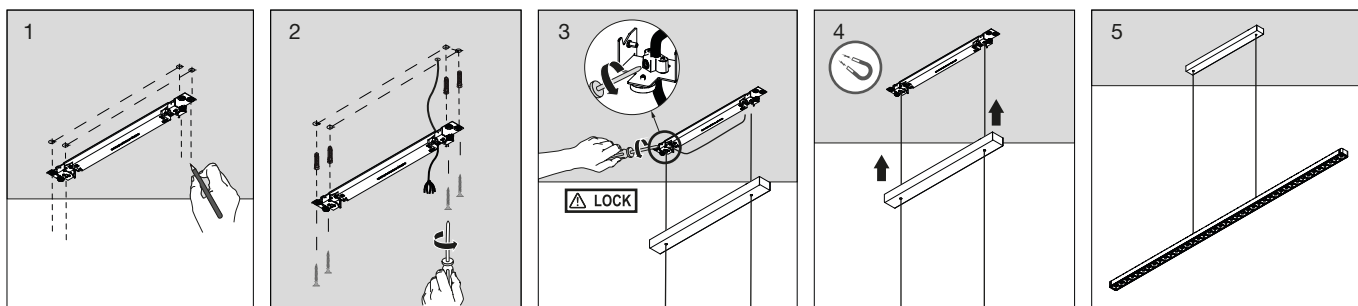

Remote Power Supply Kit

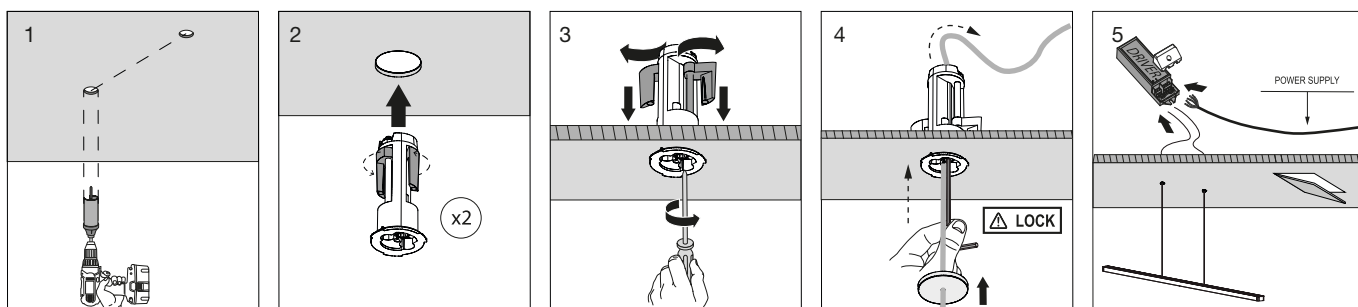

* For 1-10V and Push versions, please ask the Front Office/Technical Department / Para versiones 1-10V y Push consultar al Front Office/Departamento técnico.